

CLLP-375

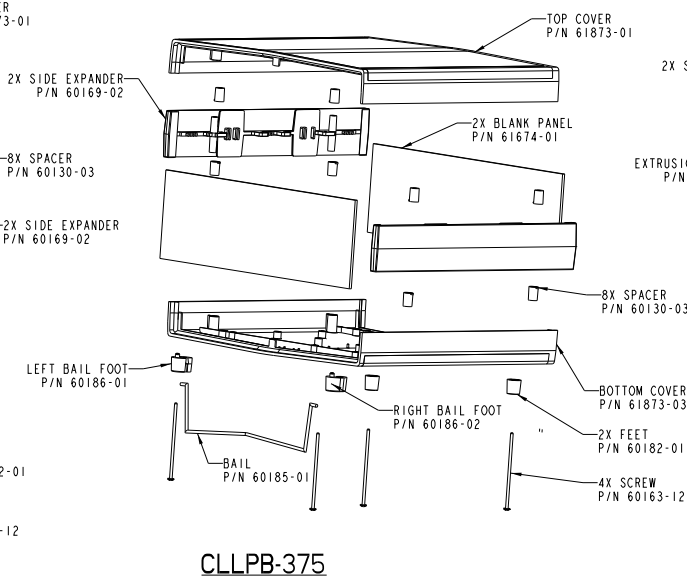

CLLPB-375

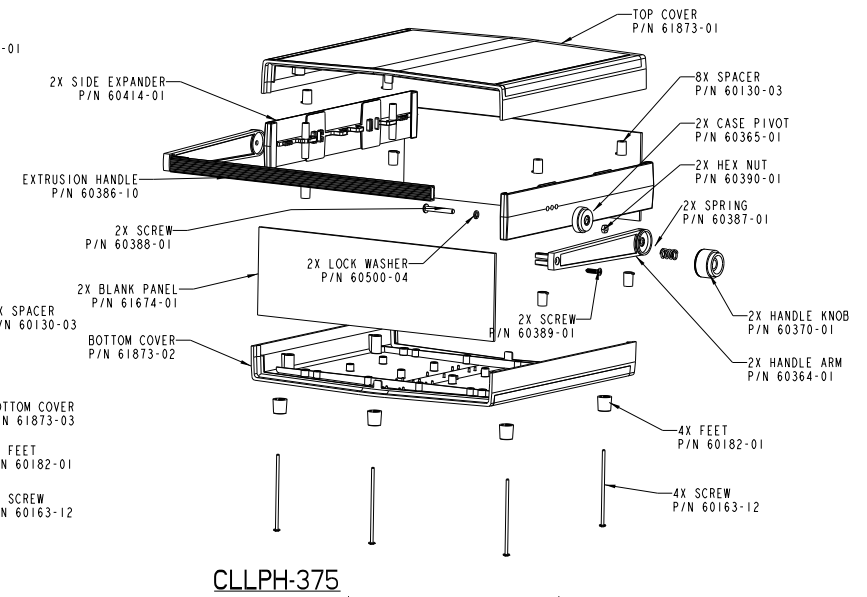

CLLPH-375

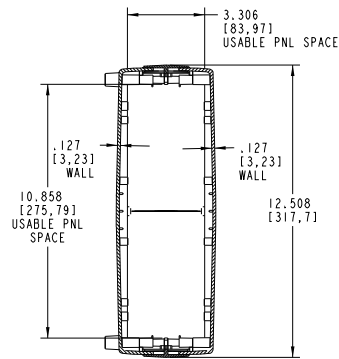
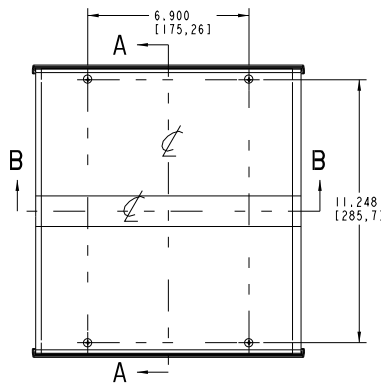

SECTION A-A

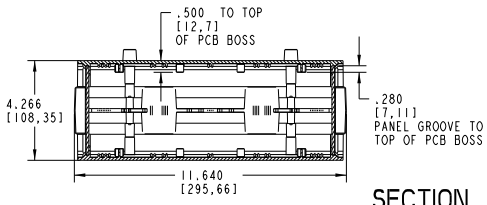
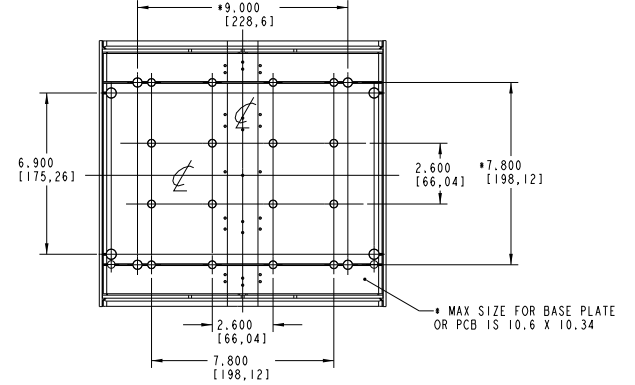
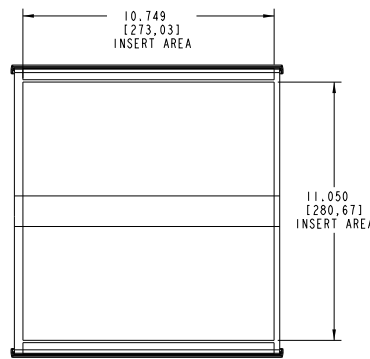

SECTION B-B

PACINTEC®
 1-610-361-4200
CLLP-375, CLLPB-375
CLLPH-375

VISIT **PACINTEC®**
 ON THE WORLD WIDE WEB
www.pactecenclosures.com

COLOR / MATERIAL CODE		
COLOR	94HB	94VO
BLACK	000	028
P.C.BONE	039	060

DRAWING NUMBER	REV
79500	A